

11-3-2014

Autoantibodies to the NY-ESO-1 Tumor Antigen in Metastatic Melanoma: Sialylation of the Fc Region of Immunoglobulin G Induces Differential Expression Signatures of Inflammatory Molecules During Dendritic Cell Differentiation and Maturation

Martin Oaks

Nathaniel Rein

John O. Richards

James Shaffer

Follow this and additional works at: <https://aurora.org/jpcrr>

 Part of the [Genetics and Genomics Commons](#), [Immunology and Infectious Disease Commons](#), [Laboratory and Basic Science Research Commons](#), [Medical Cell Biology Commons](#), [Neoplasms Commons](#), and the [Oncology Commons](#)

Recommended Citation

Oaks M, Rein N, Richards JO, Shaffer J. Autoantibodies to the NY-ESO-1 tumor antigen in metastatic melanoma: sialylation of the Fc region of immunoglobulin G induces differential expression signatures of inflammatory molecules during dendritic cell differentiation and maturation. *J Patient-Centered Res Rev.* 2014;1:171-187. doi: 10.17294/2330-0698.1038

Journal of Patient-Centered Research and Reviews (JPCRR) is a peer-reviewed scientific journal whose mission is to communicate clinical and bench research findings, with the goal of improving the quality of human health, the care of the individual patient, and the care of populations.



Autoantibodies to the NY-ESO-1 Tumor Antigen in Metastatic Melanoma: Sialylation of the Fc Region of Immunoglobulin G Induces Differential Expression Signatures of Inflammatory Molecules During Dendritic Cell Differentiation and Maturation

Martin Oaks, PhD,^{1,2} Nathaniel Rein,¹ John O. Richards, PhD,^{1,2} James Shaffer, MS¹

¹Aurora St. Luke's Medical Center, Aurora Health Care, Milwaukee, WI

²Aurora Research Institute, Aurora Health Care, Milwaukee, WI

Abstract

Purpose: We tested the hypothesis that different glycoforms of antibodies from patients with metastatic melanoma have different functional effects on human dendritic cell differentiation and maturation.

Methods: Antibodies to the cancer antigen NY-ESO-1 were affinity-purified from patients with melanoma and further fractionated into different glycoforms by lectin chromatography. Sialic acid-rich and sialic acid-poor fractions of these immunoglobulin G antibodies (IgG) were added to dendritic cell cultures during both differentiation and maturation, and the resulting cellular messenger RNA (mRNA) and culture supernatants were tested by microarray and enzyme-linked immunoassay for molecules related to inflammatory pathways.

Results: We identified unique mRNA and secreted protein signatures that were induced by different glycoforms of IgG during dendritic cell differentiation and maturation. Among the variety of mRNA and proteins induced by the sialic acid-rich IgG fraction, we found a dramatic increase in levels of the melanoma growth factor CXCL1.

Conclusions: Our findings support the concept that alternate glycoforms of IgG induce differing functional programs of dendritic cell differentiation and maturation. The data also support the concept that the functional phenotype of IgG is related to glycosylation. Thus, subtle changes in glycan structure can change the effector function of IgG from an inflammatory to an anti-inflammatory program. This work highlights the importance of the interface between tumors and the immune system, revealing a potential explanation as to why tumors persist and progress despite potent immune responses against them. (*J Patient-Centered Res Rev* 2014;1:171-187.)

Keywords

tumor immunity, anti-inflammatory, NY-ESO-1, immunoglobulin G, glycosylation, sialic acid, dendritic cells, melanoma

Glossary of Abbreviations

DC = dendritic cell

DCIR = dendritic cell immunoreceptor

DC-SIGN = dendritic cell-specific intercellular adhesion molecule-3-grabbing nonintegrin

ELISA = enzyme-linked immunoassay

Fc = fragment crystallizable

IgG = immunoglobulin G

iDC = immature dendritic cell

IL = interleukin

IVIG = intravenous immunoglobulin

mDC = mature dendritic cell

mRNA = messenger ribonucleic acid

qRT-PCR = quantitative reverse transcription polymerase chain reaction

Sia = sialic acid

SNA = *Sambucus nigra* agglutinin

ST6Gal-I = β -galactoside α 2,6-sialyltransferase

Introduction

Tumor immunologists have known for many years that cancers develop and progress in the host despite potent immune responses against them.¹ These immune responses consist of both cell-mediated and antibody-mediated varieties.^{2,3} It has been estimated that nearly 95% of patients who bear tumors have measurable antibodies against tumor antigens, and most of these antibodies are of the immunoglobulin G (IgG) isotype.¹ These findings seem to be at odds with our experience in the field of organ transplantation. It has been known for more than 40 years that organs transplanted

Correspondence: Martin Oaks, PhD, 2900 W. Oklahoma Avenue, Milwaukee, WI, 53215, Phone: 414-649-7188, Email: martin.oaks@aurora.org

across the immunological barrier of antibody are commonly rejected.⁴ In fact, antibody-mediated rejection of both acute and chronic forms is the major cause of cardiac and kidney graft loss in the late posttransplant period.^{5,6} One possible explanation for this seemingly paradoxical observation is that the antibodies formed against tumors may have different effector functions than those that mediate rejection. It is well-established that the differing effector functions of IgG reside within their fragment crystallizable (Fc) regions and are greatly influenced by the N-linked glycan structure at Asn-297.^{7,8} The IgG glycans are complex carbohydrates (sugars) that are covalently linked to the IgG molecule (Figure 1); the ones that are the subject of our current study have the terminal sugar sialic acid (Sia).

We recently described a population of antibodies in patients with melanoma and breast cancer who are candidates for anti-inflammatory antibodies.⁹ That is, rather than eliciting protective pathways that lead to tumor elimination, these antibodies promote downregulation of the cellular inflammatory response against the tumor, and also may dampen immune pathways via induction of regulatory networks including regulatory T-cells and/or myeloid-derived suppressor cells.^{10,11} We recently showed that antibodies to the NY-ESO-1 antigen are a relatively frequent finding in metastatic melanoma, are of the IgG class, and commonly have a glycan signature within the Fc region of IgG that terminates in α 2,6-linked Sia.⁹ For this reason, we chose the NY-ESO-1 tumor antigen/antibody system to explore the functional activities of different glycoforms of IgG on their ability to influence inflammatory pathways in human monocyte-derived dendritic cells (DC). We also showed that, via their Fc glycans, IgG bound the human dendritic cell-specific intercellular adhesion molecule-3-grabbing nonintegrin (DC-SIGN) CD209 receptor. DC-SIGN is expressed on human DC and is known to be important in both inflammatory and immunoregulatory pathways. Since DC are central to presentation of antigens to the immune system, we hypothesized these antibodies might affect DC differentiation and/or maturation.

In this communication we compare the functional activities of highly sialylated versus poorly sialylated antibodies to the melanoma antigen NY-ESO-1 on human DC differentiation and maturation. We found dramatic differences in the ability of these different populations of antibodies to regulate the messenger RNA (mRNA) of cytokine, chemokine and cell surface receptors on DC. In addition, we found that sialylated IgG antibodies induce a marked increase in the melanoma growth factor CXCL1 during DC differentiation.

These findings further substantiate the contrasting functional activities of different glycoforms of antibodies of the same antigenic specificity as well as provide more evidence illustrating the important role of the immune system in the development and progression of melanoma.

Methods

Subjects and Blood Samples

Blood samples from human subjects were obtained under the oversight of our institutional review board. Patient samples for NY-ESO-1 studies were recruited through the high-dose interleukin-2 (IL-2) treatment unit at Aurora St. Luke's Medical Center. All patients enrolled had metastatic melanoma, had failed prior conventional chemotherapy, and were either currently being treated or evaluated for IL-2 therapy. Samples from patients who had prior IL-2 therapy were obtained a minimum of 3 months since the most recent IL-2 administration. Samples were selected for analysis when they had a minimum average titer of 1/350 (range: 1/350-1/300,000) determined by enzyme-linked immunoassay (ELISA) as described by Oaks et al.⁹ The sera (from 12 patients) were pooled based on all available samples in order to maximize yield of the Sia⁺ IgG fraction. Monocytes were obtained by elutriation from peripheral blood buffy coats as described by Garlie and Timler.¹² This method routinely enriches monocytes to >87% as determined by flow cytometry for the CD14 cell surface marker (data not shown).

Peptides and Lectin

A 40-mer peptide (ESO:1-40) from the NY-ESO-1 protein was used as the target antigen in the affinity purification process. This sequence represents a dominant B-cell epitope, and is recognized by sera from a wide variety of cancer patients.¹³ A peptide (MQAEGRGTGGSTGDADGPGGPGIPDGPGGNAGGPGGEAGATC) was synthesized, purified by high-performance liquid chromatography, and conjugated to a sepharose SulfoLink[™] resin (Pierce Biotechnology, Rockford, IL) by New England Peptide (Gardner, MA). Agarose-conjugated *Sambucus nigra* agglutinin (SNA) lectin (#AL-1303) was purchased from Vector Laboratories (Burlingame, CA).

Affinity Purification of IgG and Lectin Chromatography

As described in past reports, IgG was enriched from serum samples by affinity chromatography followed by SNA lectin chromatography.⁹ The resulting fractions (SNA⁺ and SNA⁻) were exchanged into phosphate buffered saline (pH 7.4) with a desalting column and quantitated by ELISA as described in the same publication. Material that did not bind the SNA

lectin column is referred to as Sia⁻ IgG and material that was retarded and eluted from the lectin as Sia⁺ IgG throughout the manuscript. The different SNA fractions of IgG were added to cell culture experiments to a final concentration of 10 ug/mL. Control cultures without any IgG added were performed in each experiment and all data expressed as

change relative to the baseline from these controls. During generation of immature dendritic cells (iDC), fractions were added at the initiation of the culture. Likewise, maturation experiments included addition of SNA fractions upon addition of lipopolysaccharide to iDC.

Dendritic Cell Culture

Immature DC were generated from monocytes by plating 4×10^6 cells/well in six well plates (Costar®, Corning Life Sciences, Tewksbury, MA) containing 2-mL/well culture medium. Culture medium was RPMI-1640 supplemented with 10% fetal bovine serum, 50 ug/mL gentamycin, 100 U/mL penicillin, 100 ug/mL streptomycin, 1000 IU/mL recombinant granulocyte-macrophage colony stimulating factor and 500 IU/mL IL-4 (R&D Systems, Minneapolis, MN). After 5 days of culture at 37° C and 5% CO₂ in air, the cells were harvested. This process is commonly referred to as DC differentiation, and the cells derived from these cultures are commonly referred to as immature DC. The yield from these cultures was typically 1×10^6 cells. We refer to these cells as iDC throughout the remainder of the manuscript. At this stage, approximately 80% of the cells had iDC morphology and had the phenotype CD14⁺, CD11c⁺, CD80⁺, CD86⁺⁺, HLADR⁺ and CD83⁻.

Dendritic cell maturation was performed by 48 hours of culture of 1×10^6 iDC in the presence of 500 pg/mL E. coli lipopolysaccharide. Mature dendritic cells are referred to as mDC throughout the manuscript.

Microarray

Microarray studies were performed by quantitative reverse transcription polymerase chain reaction (qRT-PCR). Briefly, 1×10^5 cells were pelleted by centrifugation and mRNA enriched with the use of an RNeasy Plus Micro Kit (No. 74034, Qiagen, Germantown, MD). RNA (500-ng input) was reverse transcribed with the use of an RT² First Strand Kit (No. 330401, Qiagen), and the entire contents of the complementary DNA were added to the microarray. qRT-PCR microarrays for inflammatory pathways and DC/antigen-presenting cell pathways (PAHS-077ZA and PAHS-406ZA, respectively) were purchased from Qiagen. qRT-PCR was performed on an ABI Prism® 7900HT thermocycler (Life Technologies, Grand Island, NY), and the data analyzed by the $\Delta\Delta C_t$ method. Transcripts were quantitated relative to the “housekeeping” genes, β -actin, β -2-microglobulin, glyceraldehyde-3-phosphate dehydrogenase, hypoxanthine phosphoribosyltransferase-1 and large ribosomal protein. Internal controls for reverse transcription and the PCR process were performed with

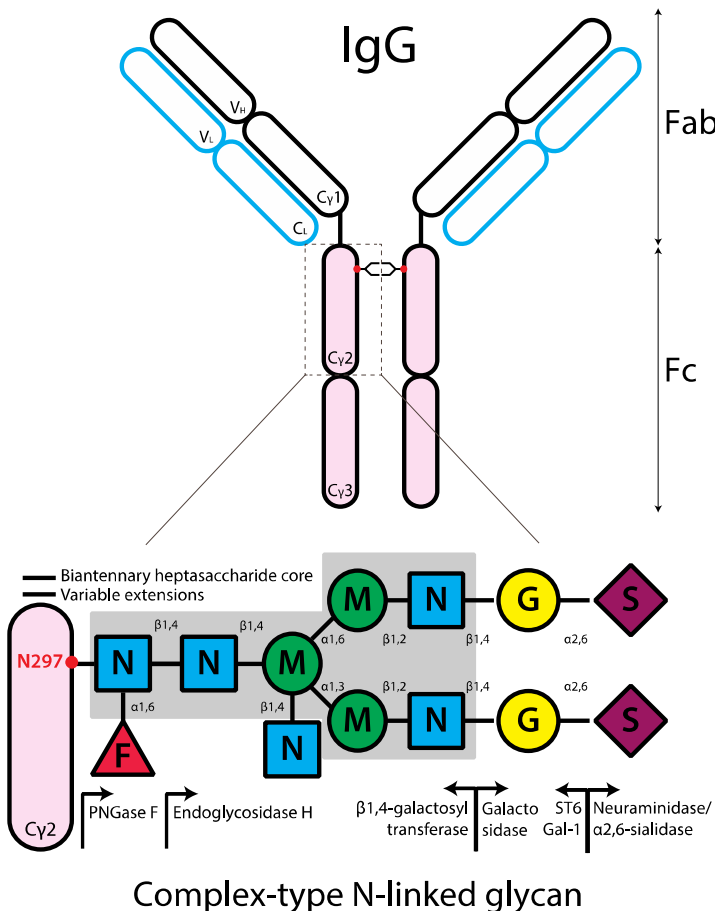

Figure 1. Schematic representation of an immunoglobulin G (IgG) antibody with a sialylated glycan attached to the Fc region. The Fc region of the antibody (pink ovals) attaches to the immune cell. The glycans attached to the Fc region are important in this interaction. Glycans are chains of sugar molecules (carbohydrate). A sialylated glycan is one with a nine-carbon sugar (sialic acid) attached to the glycan (in this example, a complex-type N-linked glycan). The Fab portion of the antibody (empty ovals) binds the foreign material, such as a bacterium or an abnormal cell, in a “lock and key” fashion. The immune cell or other material attached to the antibody at the Fc portion can then destroy the foreign material. V_H, variable region of IgG heavy chain (black outline); V_L, variable region of IgG light chain (blue outline); C_L, constant region of IgG light chain; Cy1-3, three domains of the IgG heavy chain constant region; F, fucose; N, GlcNAc; M, mannose; G, galactose; S, sialic acid. (Reprinted from [Shade KTC, Anthony RM. Antibody glycosylation and inflammation. Antibodies. 2013;2:392-414](#), with permission from MDPI Open Access Publishing.)

each assay. The lack of contamination of genomic DNA was verified by PCR for each sample tested in microarray.

Flow Cytometry

Indirect stains were used to determine NY-ESO-1 antigen expression on DC. Approximately 200,000 DC were stained in a total volume of 100 μ l with anti-NY-ESO-1 (clone E978, Life Technologies) in bovine serum albumin staining buffer (BD Biosciences, San Jose, CA). Detection of monoclonal anti-NY-ESO-1 was with a goat anti-mouse IgG-PE (Jackson ImmunoResearch Laboratories, West Grove, PA), and human anti-NY-ESO-1 was detected with phycoerythrin-labeled anti-human IgG (Jackson ImmunoResearch).

Direct flow cytometry stains were used to determine if sialylated antibodies influenced expression of common DC cell-surface antigens during differentiation and maturation. Approximately 200,000 cells were stained in a total volume of 100 μ l bovine serum albumin staining buffer with anti-HLA-DR PE-CF594 (clone G46-6, BD Biosciences), anti-CD40 APC-H7 (clone 5C3, BD Biosciences), anti-CD86 PE-Cy7 (clone 2331(FUN-1), BD Biosciences), anti-CD209 PE (clone DCN46, BD Biosciences), anti-CXCR2 APC (clone 48311, R&D Systems), anti-CD80 FITC (clone 37711, R&D Systems) and anti-CD83 PerCP-Cy5.5 (clone HB15e, BioLegend, San Diego, CA). Stained cells were analyzed on a LSR Fortessa (BD Bioscience), and data analysis was performed with FCS Express software.

ELISA

Quantitation of select chemokines and cytokines was performed by ELISA. Primary and biotinylated secondary antibodies for these were all purchased from R&D Systems. Antigen capture and detection of biotinylated antibody was performed as described by Oaks et al.⁹

Results

Neither iDC nor mDC Express the NY-ESO-1 Antigen

We used flow cytometry to detect surface NY-ESO-1 expression on both iDC and mDC in order to ensure the effects of affinity-purified NY-ESO-1 antibodies were due to differences in the Fc region of the antibody and not related to recognition of their cognate antigen. Figure 2A demonstrates that neither cell type expressed cell surface NY-ESO-1 when measured by binding of a mouse monoclonal antibody to human NY-ESO-1 antigen. Likewise, affinity-purified human IgG with specificity for NY-ESO-1 did not bind iDC or mDC when assessed by flow cytometry (Figure 2B). It is important to note that although we were unable to detect

IgG binding to DC by flow cytometry, this does not preclude interaction of the Fc region with its receptors on DC. IgG binding via Fc may be below the detection limits of flow cytometry, or alternatively, binding via receptors that interact with Fc may block epitopes recognized by the secondary antibody. We favor the latter possibility, as most secondary reagents to IgG recognize epitopes in the hinge region of IgG, and these would likely be inaccessible on IgG bound to DC receptors.

Effect of Fc Glycosylation on mRNA Expression During DC Differentiation and Maturation

We used qRT-PCR microarrays on mRNA from iDC to evaluate the differential effects of Sia⁺ and Sia⁻ fractions of anti-NY-ESO-1 IgG during the differentiation of blood

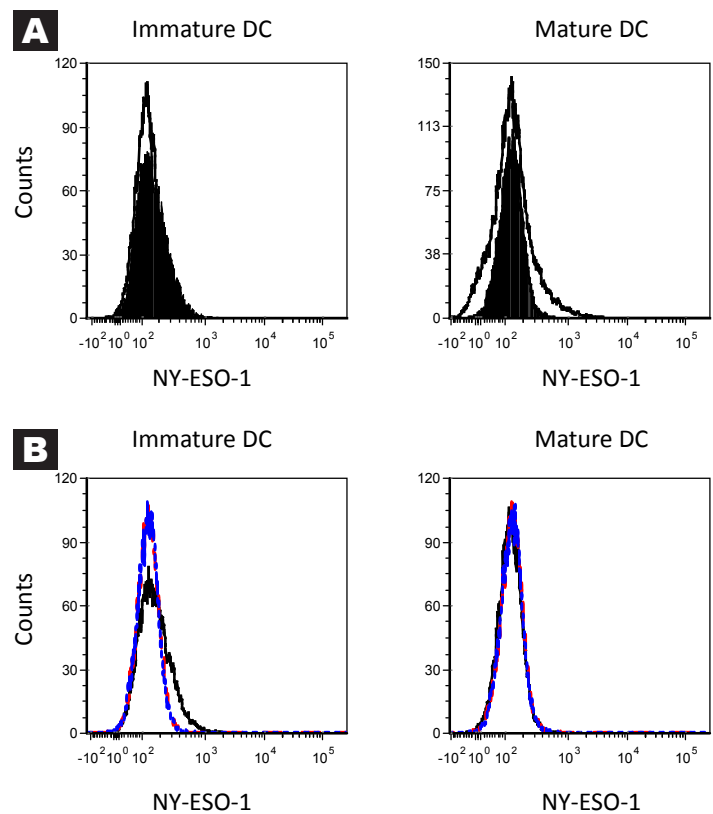

Figure 2. Dendritic cells (DC) do not express surface NY-ESO-1. DC were cultured in 1000 U of each granulocyte-macrophage colony-stimulating factor and interleukin-4 and stained for NY-ESO-1 expression. **A:** Indirect fluorescence detection of NY-ESO-1. The filled histogram reflects control anti-mouse immunoglobulin G-phycoerythrin (IgG-PE), and the open histogram reflects NY-ESO-1 plus anti-mouse IgG-PE. **B:** Indirect staining of human affinity-purified antibodies specific for NY-ESO-1 that had high sialylation (blue), low sialylation (red) and control (black). The detection reagent was anti-human IgG-PE.

monocytes into iDC as well as the maturation of iDC into mDC. To this end, we surveyed mRNA expression of 138 different genes with the use of microarray panels of genes previously identified to be positively or negatively regulated in inflammatory pathways or pathways related to antigen presentation. Figure 3 shows scatter plots of the magnitude of change of individual genes up- or downregulated during iDC generation. Figure 3A shows the grouping of all genes in the microarray. Sia⁻ IgG had little effect on both the number of different mRNA species and the magnitude of their differences compared to control cultures. By contrast, the Sia⁺ fraction of IgG had dramatic impact on both the number of genes up- or downregulated as well as the magnitude of their expression levels. For example, compared to control cultures, differences of various mRNA species ranged from +20-fold to -80-fold for Sia⁺ IgG-treated DC. For the sake of visualization of the differential effects of these IgG glycoforms, we generated different expression networks based on functional relatedness of different genes (Figure 3B–3I). Comparison of the differential activities of Sia⁺ and Sia⁻ fractions of IgG when measured by individual mRNA species and the magnitude of mRNA quantity showed the highest difference among transcripts related to cell recruitment/adhesion (Figure 3C), antigen presentation (Figure 3D), and proteins involved in inflammation (Figure 3H). With the exception of a single gene transcript, specifically the CD28 mRNA, there were minimal effects on genes related to cell proliferation, activation, and maturation (Figure 3B).

With respect to the differential effects of Sia⁺ and Sia⁻ IgG fractions on DC maturation, the most notable effects were on the tendency for the Sia⁺ fraction to result in a downregulation of mRNA related to cell maturation and activation (Figure 4B) and synthesis of molecules involved in inflammation (Figure 4H). An important observation to be made in regard to the activity of the Sia⁻ fraction is that under both settings of DC differentiation and maturation, most of the genes in our survey were minimally affected, as most changes relative to control are clustered near zero. The effect is best visualized by comparison of each functional set under conditions of differentiation and maturation. Notice that the dispersion of number of genes up- or downregulated is rather limited when under the influence of Sia⁻ IgG and maximized by Sia⁺ IgG (compare Figures 3A and 4A).

A numerical ranking of the fold differential effects of Sia⁺ and Sia⁻ IgG in up- and downregulation during

DC differentiation is shown in Table 1. For purpose of presentation, we arbitrarily limited this listing to genes that showed >4-fold increase or decrease in expression. The full data set obtained from these experiments is shown in Online Appendix 1. Of the eight mRNA with increased expression, five are related to migration and adhesion of leukocytes, suggesting an important change in cell-cell interactions. Interestingly, CXCL1, while chemotactic for inflammatory cells, also stimulates the proliferation of melanoma cells. The 8-fold upregulation of this mRNA is in concert with a dramatic increase in secreted protein.

Table 2 provides a summary of mRNA with >4-fold differential produced by the Sia⁺ fraction during DC maturation. Only two mRNA were significantly differentially upregulated during DC maturation (CD1a and IL-12B); most of the differential effects of Sia⁺ IgG were downregulation of mRNA related to cell migration, adhesion and antigen presentation. Interestingly, Sia⁺ IgG induced a dramatic reduction in CXCL19 mRNA under conditions of maturation while promoting an increase of the same mRNA during differentiation. Another interesting finding is the marked downregulation (approximately 8-fold) of the mRNA for the IgG-activating Fc receptor (CD64) during maturation in the presence of Sia⁺ IgG. Downregulation of IgG-activating Fc receptors is a common feature of the anti-inflammatory effects of intravenous immunoglobulin (IVIG).¹⁴ The full data set for mRNA changes during DC maturation is illustrated in Online Appendix 2.

The Venn diagrams depicted in Online Appendix 3 illustrate the dramatic differences in the effects of Sia⁺ and Sia⁻ IgG populations on inflammatory mRNA during DC differentiation and maturation. The Sia⁺ fraction of IgG was responsible for the vast majority of genes either up- or downregulated during both DC differentiation and maturation, whereas the Sia⁻ fraction affected only a small number of genes. Also, there was little overlap in the functional activities of the different Sia fractions. Under conditions of DC maturation, the Sia⁻ fraction was essentially inert in terms of mRNA changes compared to control, whereas the Sia⁺ fraction showed a predominantly downregulatory influence on multiple inflammatory mRNA.

IgG Glycosylation Does Not Affect Phenotype of Common Lineage Markers

We used flow cytometry to assess any differential effects of Sia⁺ and Sia⁻ NY-ESO-1 IgG on cell surface lineage markers during conditions of DC differentiation and maturation. Figure 5A shows histogram overlays obtained from control

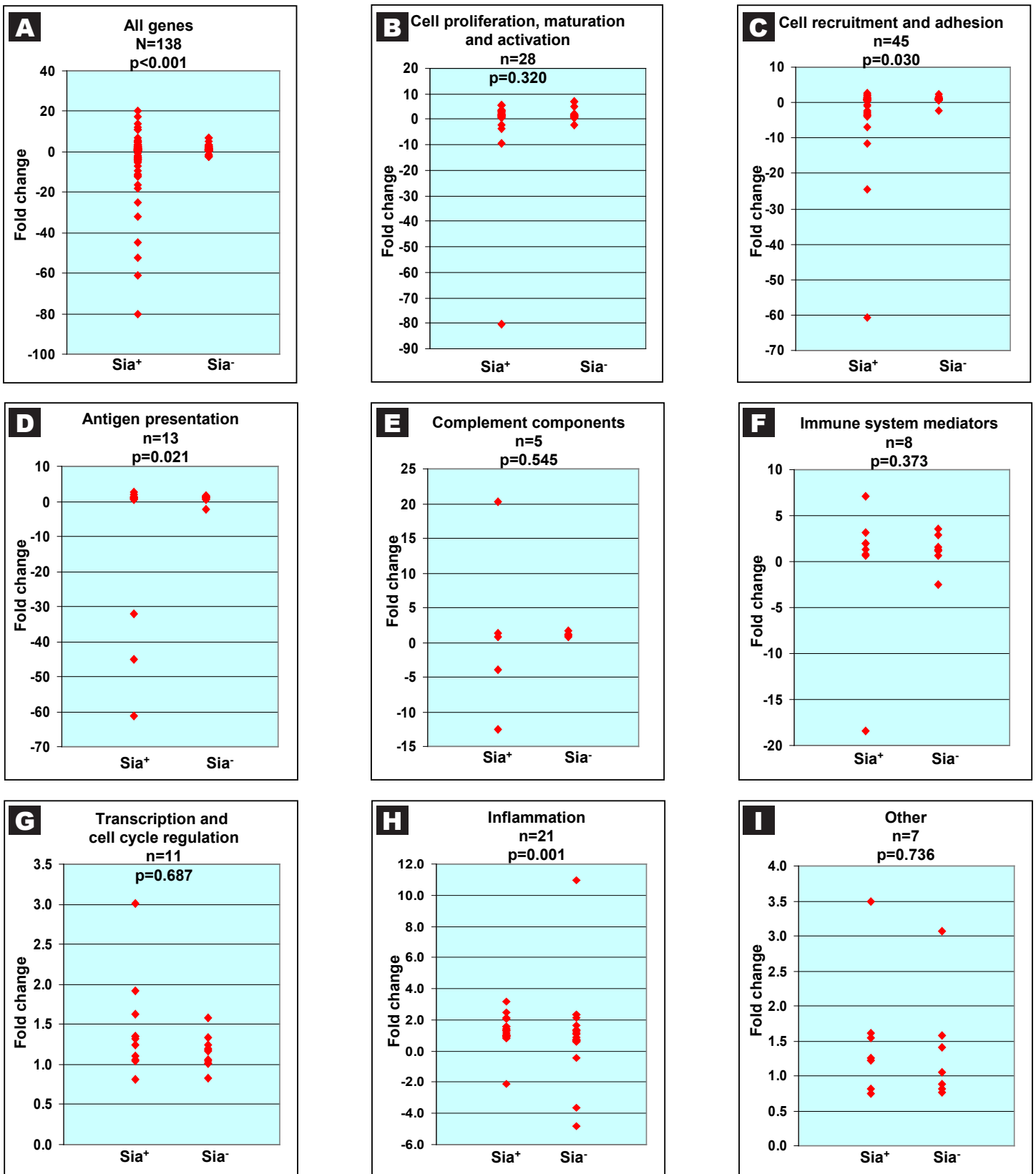

Figure 3. Differential effects of *Sia*⁺ and *Sia*⁻ IgG antibodies on mRNA during dendritic cell differentiation. **A:** Scatter plot of fold changes in mRNA of all genes surveyed by microarray quantitative reverse transcription polymerase chain reaction (qRT-PCR). **B–I:** Scatter plots of genes based on functional class of genes. Statistical analysis was performed on raw cycles to threshold (C_t) values, comparing *Sia*⁺ vs. *Sia*⁻. Data are expressed graphically as fold change relative to control cultures (without IgG) using the $2^{-\Delta\Delta C_t}$ calculation. Data are from a representative experiment of more than 10 independent cell cultures and qRT-PCR experiments.

cultures (no IgG added) compared to Sia⁺ and Sia⁻ fractions of IgG to NY-ESO-1 during DC differentiation. Figure 5B shows the same under conditions of DC maturation. Overall, neither Sia fraction had a remarkable effect on the lineage phenotype of iDC or mDC under these culture conditions. Although CXCR2 is not a known phenotypic marker of DC, it was assessed by flow cytometry because of the increase in its natural ligand, CXCL1 (melanoma growth factor activity- α) mRNA and protein (see ELISA data). There were no changes in CXCR2 mRNA levels during generation of either iDC or mDC in the presence of either Sia fraction of IgG.

Differential Effects of Fc Glycosylation on Cytokine and Chemokine Secretion During iDC and mDC Generation

We used ELISA methods to detect secretion of cytokines and chemokines into cell culture supernatants of iDC and mDC treated with different SNA fractions of NY-ESO-1 IgG (Figure 6). In some cases, these analytes were selected *a priori* because of their known relationships to DC function (e.g. IL-6, IL-10, IL-13)¹⁵ or functional pathways mediated by IVIG therapy (IL-33).¹⁶ In other cases, chemokines were chosen based on our analysis of changes in mRNA levels found by microarray (e.g. CCL-5, CCL-13, CCL-19, CXCL1, etc.).

During differentiation, the Sia⁺ IgG fraction induced nearly 100% inhibition of the chemotaxin CCL-13 protein compared to controls (Figure 6B). By contrast, >200-fold and >20-fold increases of CXCL1 and IL-6, respectively, were observed in the culture supernatants (Figures 6C and 6D) when compared to controls. Despite the increases in its mRNA, only a very modest increase of CCL-5 protein was observed in these cultures, and levels of thrombospondin were largely unchanged (ELISA data not shown). It should be noted that although IL-6 and tumor necrosis factor (TNF)- α are commonly thought of as inflammatory cytokines, their anti-inflammatory properties also have been described,^{17,18} so the increased levels of these proteins in culture supernatants is not inconsistent with anti-inflammatory pathways. Although the Sia⁺ IgG fraction induced a nearly 14-fold increase in CCL-19 mRNA, its soluble ligand was not detectable in culture supernatants. Neither IL-13 nor IL-33, both cytokines that have been associated with inflammation, was detected in culture supernatants of iDC under control conditions or either treatment group.

Under conditions of DC maturation, we observed marked reduction in secreted CCL-5, CCL-13, IL-6 and CCL-19 proteins (ranging from 72% to 82%) compared to control values (Figures 7A, 7B, 7D and 7F), and more modest reductions in thrombospondin and IL-10 proteins (32% and

40%, respectively). There was a nearly 6-fold increase of CXCL1 protein when cells were treated with the Sia⁺ IgG (Figure 7C), and a 3-fold increase in TNF- α (Figure 7G). Similar to experiments under conditions of differentiation, secretion of IL-13 and IL-33 were undetectable during DC maturation.

The Venn diagrams shown in Online Appendix 4 illustrate the limited overlap of the cytokines and chemokines secreted during DC differentiation and maturation. There is a reciprocal relationship of IL-6 and CCL-5 protein expression during differentiation, as the Sia⁺ fraction appears to augment their production whereas the Sia⁻ fraction appears to dampen them. It is also noteworthy that while the Sia⁺ fraction appears to augment CCL-5 and IL-6 production during DC differentiation, it appears to blunt expression of both molecules during DC maturation.

Discussion

Our data provide four important findings about the differential effects of glycan structures within the Fc domain of human IgG on DC differentiation and maturation. Firstly, the impact of IgG on both DC differentiation and maturation is predominantly related to whether the glycans of the Fc region are sialylated or not. This is true both in terms of the number of genes regulated (whether positively or negatively) as well as the magnitude of the response of individual genes. Secondly, the activity of the Sia⁻ fraction of IgG is relatively modest under both conditions of DC differentiation and maturation. Thirdly, many important factors that affect cellular chemoattraction and migration are influenced by the Sia⁺ but not the Sia⁻ fractions of IgG. Fourthly, the mRNA of several important activating receptors, such as the C3a receptor, and the Fc receptors for IgG and immunoglobulin E are dramatically reduced by Sia⁺ IgG. These findings support the concept that sialylated IgG are important immunoregulatory molecules that can influence the production and function of human DC.

Dendritic cells are central to the development of both cellular and humoral immune response.¹⁵ They process intracellular and exogenous protein antigens into peptides that are displayed on their surface by major histocompatibility complex molecules for presentation to the T-cell receptor, and also provide positive (co-stimulatory) or negative (inhibitory) signals in the form of both cell surface expression of molecules and secretion of cytokines required for T- and B-lymphocyte proliferation and differentiation. They also secrete chemokines that attract various inflammatory cells that either positively or negatively influence cell

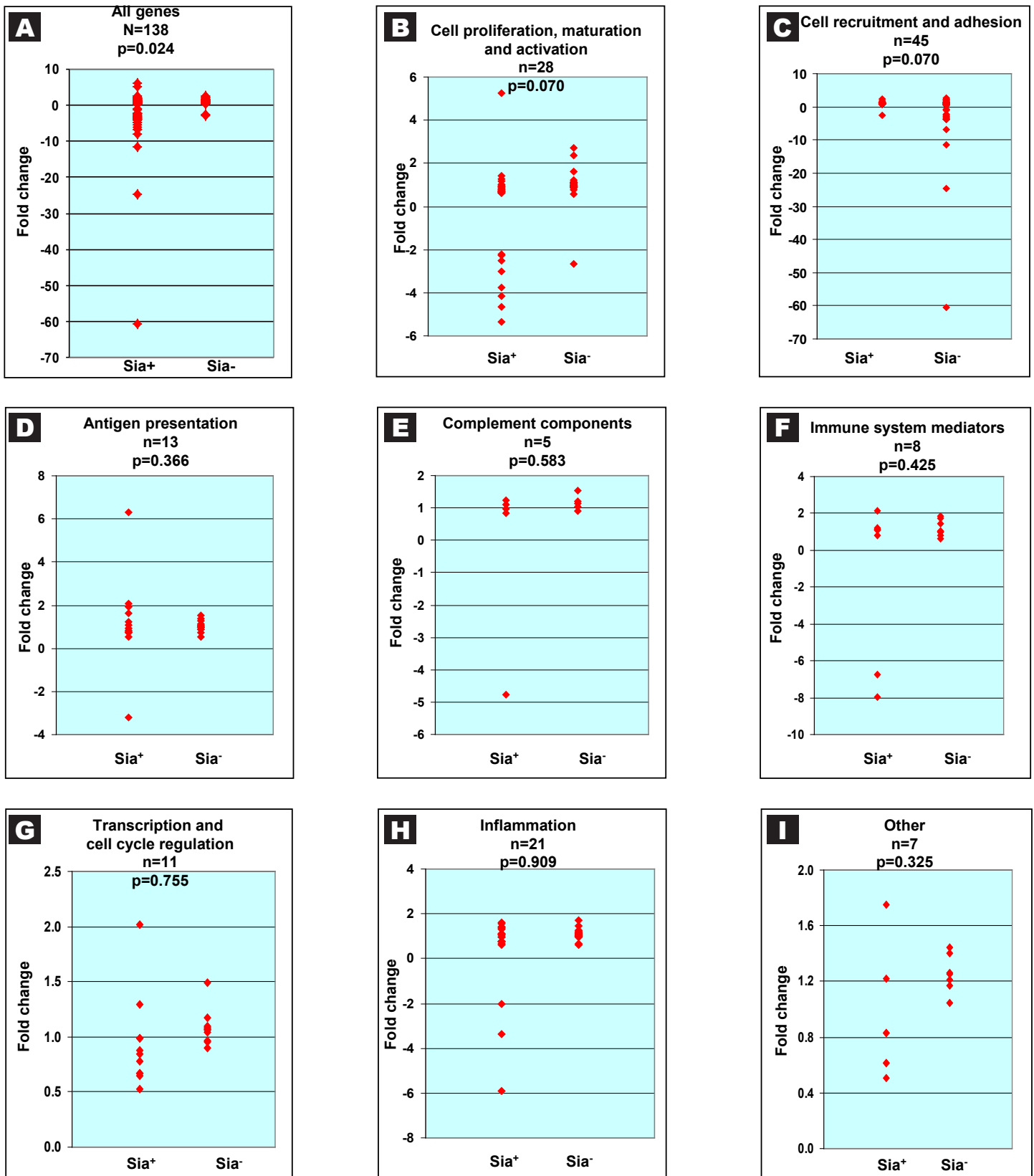

Figure 4. Differential effects of *Sia*⁺ and *Sia*⁻ IgG antibodies on mRNA during dendritic cell maturation. **A:** Scatter plots of fold changes in mRNA of all genes surveyed by quantitative reverse transcription polymerase chain reaction (qRT-PCR) microarray. **B–I:** Scatter plots of genes based on functional class of genes. Statistical analysis was performed on raw cycles to threshold (C_t) values, comparing *Sia*⁺ vs. *Sia*⁻. Data are expressed graphically as fold change relative to control cultures (without IgG) using the $2^{-\Delta\Delta C_t}$ calculation. Data are from a representative experiment of more than 10 independent cell cultures and qRT-PCR experiments.

migration into sites of inflammation. Thus, DC control both inflammatory and immunoregulatory networks in both positive and negative ways. DC also express a large variety of cell surface receptors that interact with immunoglobulins, including *activating* FcγRIIA and FcγRIIIA receptors as well as the *inhibitory* FcγRIIb receptor.¹⁹⁻²¹ Human DC also express the DC-SIGN receptor, a C-type lectin receptor that functions as a pattern recognition receptor for carbohydrates associated with a variety of microbes (including human immunodeficiency virus and mycobacteria), as well as its other known endogenous ligands, the intracellular adhesion molecules ICAM-2 and ICAM-3.^{22,23} Thus, DC-SIGN appears to be a promiscuous receptor, as it also binds sialylated forms of the Fc fragment of IgG but not their asialo counterparts.

Ravetch and colleagues^{16,24} have proposed a model by which Sia⁺ Fc of IgG drives anti-inflammatory pathways via interaction with the DC-SIGN receptor. The downstream effects of this interaction include IL-33 production that, in turn, drives the expansion of IL-4-secreting basophils and attendant upregulation of the inhibitory FcγRIIb receptor on macrophages. They propose that a switch from asialo IgG glycoforms to Sia⁺ glycoforms drives the establishment of an anti-inflammatory state from antibodies that might have previously driven inflammatory reactions.^{24,25} Overall, our data are consistent with the concept that the Sia⁺ fraction is largely responsible for the effector functions of these IgG during both DC differentiation and maturation. While the effects of the Sia⁻ fraction can be dramatic in terms of fold changes of individual mRNA, the number of target mRNA species affected is quite limited. Although the Ravetch model implicates the role of IL-33 as being central to this mechanism, we were unable to detect significant changes in IL-33 mRNA or protein by either Sia⁺ or Sia⁻ IgG during DC development. The most likely reason for this is that IL-33 is not significantly expressed by DC themselves but rather is the product of other cells involved in inflammatory processes; thus, basophil expansion in this model is dependent on IL-33 production from cells not present in our DC cultures. In fact, the major source of IL-33 is likely to be endothelia, especially those found in high endothelial venules.^{26,27} High endothelial venules enable lymphocyte homing and recirculation, and require DC signaling to function.^{28,29}

It is interesting to note that the Sia⁺ fraction of anti-NY-ESO-1 IgG induced downregulation of mRNA for the high-affinity *activating* Fc receptors for IgG and immunoglobulin E, but at different stages of DC development. Specifically, downregulation of FcγR (CD64) and FcεR mRNA was

observed during DC differentiation and maturation, respectively. The CD64 complex includes both the FcγRIa and FcγRIb molecules, both of which are activators of innate and acquired immunity.³⁰ FcεR is an important activating receptor expressed on inflammatory cells that can trigger events that result in release of mediators (such as histamine) responsible for the clinical manifestations of allergy.³¹ Our observation of downregulation of mRNA of these activating Fc receptors supports the concept that Sia⁺ Fc induces anti-inflammatory cellular pathways. In addition, in the face of a decrease in available activating Fc receptors, Sia⁺ Fc also has reduced affinity for them.³² Thus, while increased Fc sialylation reduces IgG affinity for activating Fc receptors, it could also dampen the availability of such receptors to other activating stimuli while possibly increasing Sia⁺ IgG interaction with DC-SIGN and other *inhibitory* types of receptors. Unfortunately, we were unable to evaluate mRNA and protein levels of the inhibitory FcγRIIb receptor due to a lack of availability of reagents to either species. It would be interesting to determine whether FcγRIIb levels are directly changed in our DC system or require downstream effects of IL-33, as suggested by the Ravetch model.

It is also likely that Sia⁺ IgG antibodies mediate their effects during DC differentiation and maturation via receptors other than DC-SIGN. Multiple activating and inhibitory receptors related to pattern recognition are expressed on myeloid-derived cells.^{22,23} For example, the dendritic cell immunoreceptor (DCIR/CLEC4A) is a C-type lectin domain family member with an immunoreceptor tyrosine-based inhibitory motif that is expressed on a variety of antigen-presenting cells including DC, monocytes, macrophages and B-cells.³³ Massoud and coworkers³⁴ recently described the physical interaction and the functional consequences of binding of Sia⁺ IVIG, but not Sia⁻ IVIG, to DCIR. Sia⁺ IVIG induced regulatory T-cells and inhibited inflammation in a mouse model of airway hyperresponsiveness, and this effect required DCIR expression. Determining the contributions of either DC-SIGN receptors or DCIR to these processes is outside the scope of the present study, but is a major focus of our ongoing work. Clarification of the receptors and cells involved in signaling via sialylated IgG will shed light on the relationship between glycan structure and function. In addition, advances in our understanding of the physiological basis of glycosylation of IgG and the fine structure of the glycans that mediate their function will be a key to gaining insight into the role of the immune system in the setting of cancer.

Antibodies are glycosylated by a complex group of glycosyltransferases, and more than 30 different glycan

Table 1. Differential effects of *Sia*⁺ vs. *Sia*⁻ immunoglobulin G fractions on dendritic cell differentiation

mRNA	Direction	Fold Δ^a	Description ^b
Complement component 3	↑	18.63	Role in the complement system and contributes to innate immunity
Thrombospondin-1	↑	14.96	Glycoprotein that mediates cell-to-cell and cell-to matrix interactions: also has anti-inflammatory function
Chemokine (C-C motif) ligand 19	↑	11.26	Role in normal lymphocyte recirculation and homing
Chemokine (C-C motif) ligand 5	↑	10.48	Attracts monocytes and regulates macrophage function
Chemokine (C-X-C motif) ligand 1	↑	8.67	Neutrophil chemoattractant activity melanoma growth stimulating activity, α
Interleukin-23 receptor	↑	7.64	Stimulates production of interferon- γ
Tumor necrosis factor (ligand)	↑	4.54	Induces fever; has both inflammatory and anti-inflammatory properties
CD14 molecule	↑	4.26	Mediates innate immune response
<hr/>			
Interleukin-12B	↓	4.05	Essential inducer of Th1 cell development
CD2 molecule	↓	4.17	Cell adhesion molecule found on surface of T-cells and natural killer cells
Interleukin-16	↓	4.42	Functions as a chemoattractant and is a modulator of T-cell activation
Toll-like receptor 3	↓	4.44	Mediates the production of cytokines necessary for development of effective immunity
Chemokine (C-X-C motif) receptor 1	↓	4.67	Critical for the recruitment of effector immune cells to the site of inflammation
Complement component 3a receptor 1	↓	4.80	Plays a central role in the complement system and contributes to innate immunity
Chemokine (C-C motif) ligand 2	↓	4.97	This protein is chemotactic in vitro for thymocytes and activated T-cells
Chemokine (C-C motif) ligand 24	↓	5.65	Chemotaxis in eosinophils, resting T-lymphocytes
Interleukin-10	↓	5.88	Is capable of inhibiting synthesis of proinflammatory cytokines
Chemokine (C-C motif) ligand 24	↓	7.43	Displays chemotactic activity on resting T-lymphocytes and monocytes
CD4 molecule	↓	10.11	Amplifies the signal generated by T-cell receptor I
Chemokine (C-C motif) ligand 3	↓	1.76	Recruitment and activation of polymorphonuclear leukocytes
Chemokine (C-X-C motif) receptor 2	↓	12.40	Mediates neutrophil migration to sites of inflammation
C-type lectin domain family 4, member C	↓	13.74	Activates the complement system
Vascular cell adhesion molecule	↓	16.72	Functions as a cell adhesion molecule
Fc fragment of immunoglobulin E, high-affinity 1, receptor	↓	19.00	Initiates inflammatory and immediate hypersensitivity responses
Chemokine (C-C motif) ligand 4	↓	25.69	Chemoattractant for natural killer cells, monocytes and a variety of other immune cells
CD1a molecule	↓	32.79	Mediates the presentation of primarily lipid and glycolipid antigens of self- or microbial origin
CD1b molecule	↓	45.45	Mediates the presentation of primarily lipid and glycolipid antigens of self- or microbial origin
Chemokine (C-C motif) ligand 13	↓	53.39	Chemotactic activity for monocytes, lymphocytes, basophils and eosinophils
CD1c molecule	↓	58.88	Mediate the presentation of primarily lipid and glycolipid antigens of self- or microbial origin
CD28 molecule	↓	78.04	Involved in co-stimulation, co-receptors of B7-family members

^aData are expressed as fold change (Δ) in mRNA expression relative to reference gene expression and to control (untreated) cultures, where $\text{fold } \Delta = 2^{-\frac{[(Sia^+ - \text{reference}) - (\text{control} - \text{reference})]}{[(Sia^- - \text{reference}) - (\text{control} - \text{reference})]}}$. Data are representative of more than 10 independent experiments.

^bSynopsis of gene function from GeneCards[®] (www.genecards.org).

Table 2. Differential effects of *Sia*⁺ vs. *Sia*⁻ immunoglobulin G fractions on dendritic cell maturation

mRNA	Direction	Fold Δ^a	Description ^b
CD1a molecule	↑	5.42	Mediates the presentation of primarily lipid and glycolipid antigens of self- or microbial origin
Interleukin-12B	↑	4.40	Essential inducer of Th1 cell development
Transporter 2, ATP-binding cassette, sub-family B (MDR/TAP)	↓	4.19	Restoration of surface expression of major histocompatibility complex class 1 molecules
Toll-like receptor 7	↓	4.39	Mediates the production of cytokines necessary for development of effective immunity
Chemokine (C-C motif) receptor 4	↓	4.53	Cell trafficking of various types of leukocytes
Chemokine (C-X-C motif) ligand 9	↓	4.59	T-cell chemoattractant
CD80 molecule	↓	4.69	Involved in the co-stimulatory signal essential for T-lymphocyte activation, T-cell proliferation and cytokine production
Intercellular adhesion molecule 2	↓	4.76	Involved in cellular adhesion
Chemokine (C-C motif) ligand 2	↓	4.94	Recruits monocytes, memory T-cells and dendritic cells to the sites of inflammation
Interferon regulatory factor 7	↓	5.32	Transcription factor that plays crucial roles in regulation of lineage commitment and in myeloid cell maturation
Complement component 3a receptor 1	↓	6.31	Plays a central role in the complement system and contributes to innate immunity
Interleukin-10	↓	6.95	Is capable of inhibiting synthesis of proinflammatory cytokines
Interleukin-12A	↓	7.00	Can stimulate growth and function of T-cells; mediates enhancement of cytotoxic activity of natural killer cells and cytotoxic CD8 ⁺ T-lymphocytes
Chemokine (C-C motif) ligand 5	↓	7.85	Chemotactic for T-cells, eosinophils and basophils; plays active role in recruiting leukocytes into inflammatory sites
Fc fragment of immunoglobulin G, high-affinity 1a, receptor (CD64)	↓	8.19	Plays important role in immune response
Lymphotoxin- α (tumor necrosis factor superfamily, member 1)	↓	8.62	Lymphotoxin- α mediates a large variety of inflammatory, immunostimulatory and antiviral responses
Chemokine (C-C motif) ligand 7	↓	12.50	Attracts monocytes and regulates macrophage function
Chemokine (C-C motif) ligand 19	↓	25.25	Role in normal lymphocyte recirculation and homing
Chemokine (C-X-C motif) ligand 10	↓	61.52	Chemoattractant for monocytes/macrophages, T-cells, natural killer cells and dendritic cells; promotes T-cell adhesion to endothelial cells

^aData are expressed as fold change (Δ) in mRNA expression relative to reference gene expression and to control (untreated) cultures, where $\text{fold } \Delta = 2^{-[(\text{Sia}^+ - \text{reference}) - (\text{control} - \text{reference})]} - 2^{-[(\text{Sia}^- - \text{reference}) - (\text{control} - \text{reference})]}$. Data are representative of more than 10 independent experiments.

^bSynopsis of gene function from GeneCards[®] (www.genecards.org).

species of IgG have been detected in human plasma.^{7,32} This extensive diversity provides the basis for the multiple effector functions associated with IgG.^{8,25} For example, Fc glycosylation promotes the secretion and solubility of IgG, increases its half-life in plasma, determines its ability to promote complement activation, and changes the relative affinities of the Fc fragment for a variety of cellular receptors.⁷ The N-linked glycans of the Fc region of IgG are arranged in a biantennary structure, much of which is fucosylated. A significant fraction of these glycans contain a bisecting N-acetylglucosamine and some antennae

terminate in α 2,6-Sia. The enzyme that catalyzes the terminal addition of Sia to the nascent glycan is β -galactoside α 2,6-sialyltransferase (ST6Gal-I).³⁵ Paradoxically, levels of ST6Gal-I mRNA and protein are promoted by inflammatory cytokines, specifically TNF- α , IL-1 and IL-6,^{36,37} as well as anti-inflammatory glucocorticoids.³⁸ This apparent discrepancy may be explained in part by the existence of multiple isoforms of the ST6Gal-I protein based on alternate splice variants of the mRNA and the apparent tissue specificity of their expression.³⁹⁻⁴¹ B-cells and their plasma cell descendants express ST6Gal-I and are likely

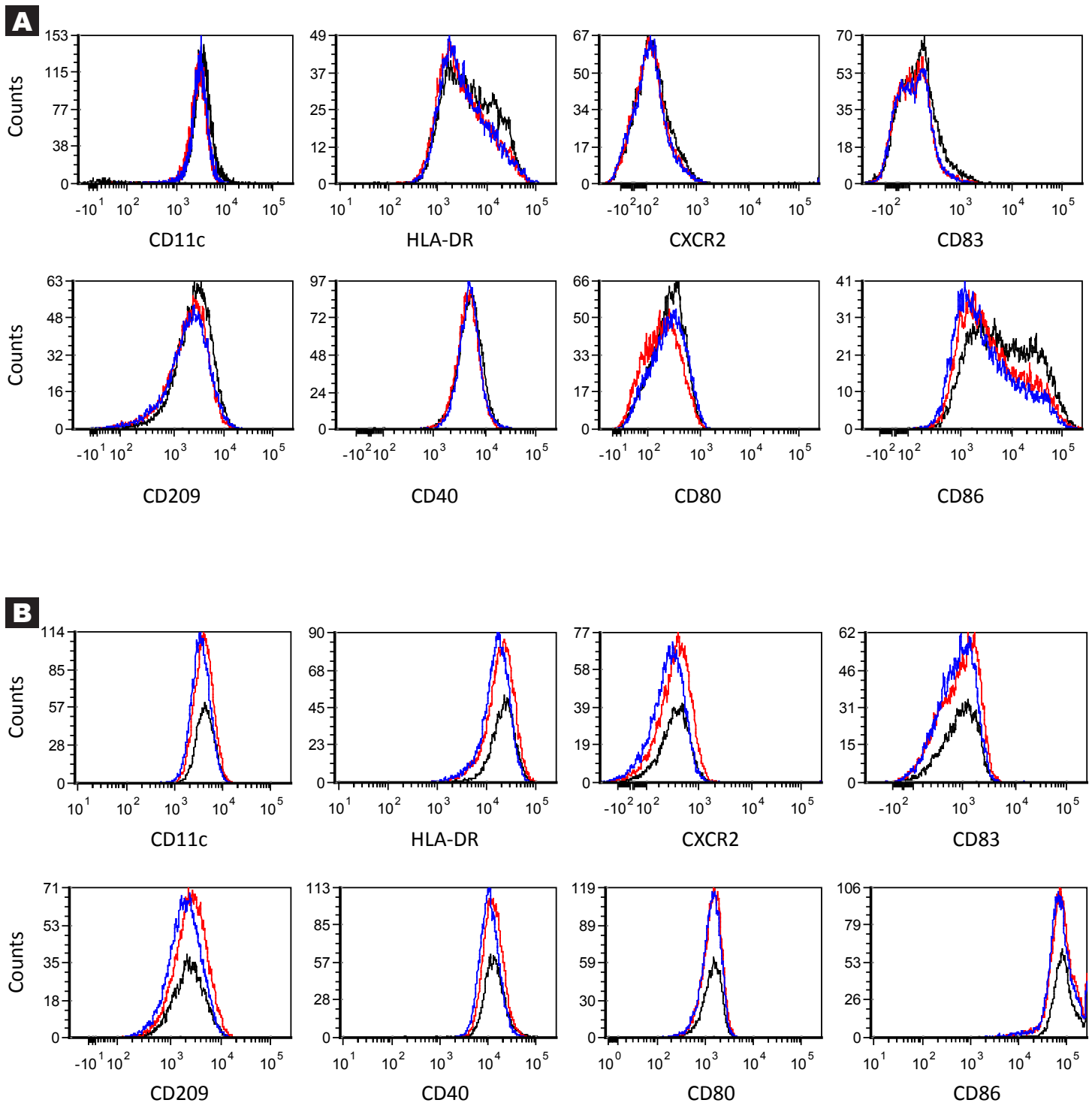

Figure 5. Antibody sialylation does not affect expression of lineage markers during dendritic cell differentiation or maturation. Dendritic cells were cultured in 1000 U of each granulocyte-macrophage colony-stimulating factor and interleukin-4. **A:** During the differentiation phase of dendritic cell cultures, cells were treated with affinity-purified NY-ESO-1 IgG that had high sialylation (red), low sialylation (blue) or were left untreated (black). **B:** Dendritic cells were mature in the presence of lipopolysaccharide. During the maturation process, cells were treated with affinity-purified NY-ESO-1 IgG that had high sialylation (red), low sialylation (blue) or were left untreated (black).

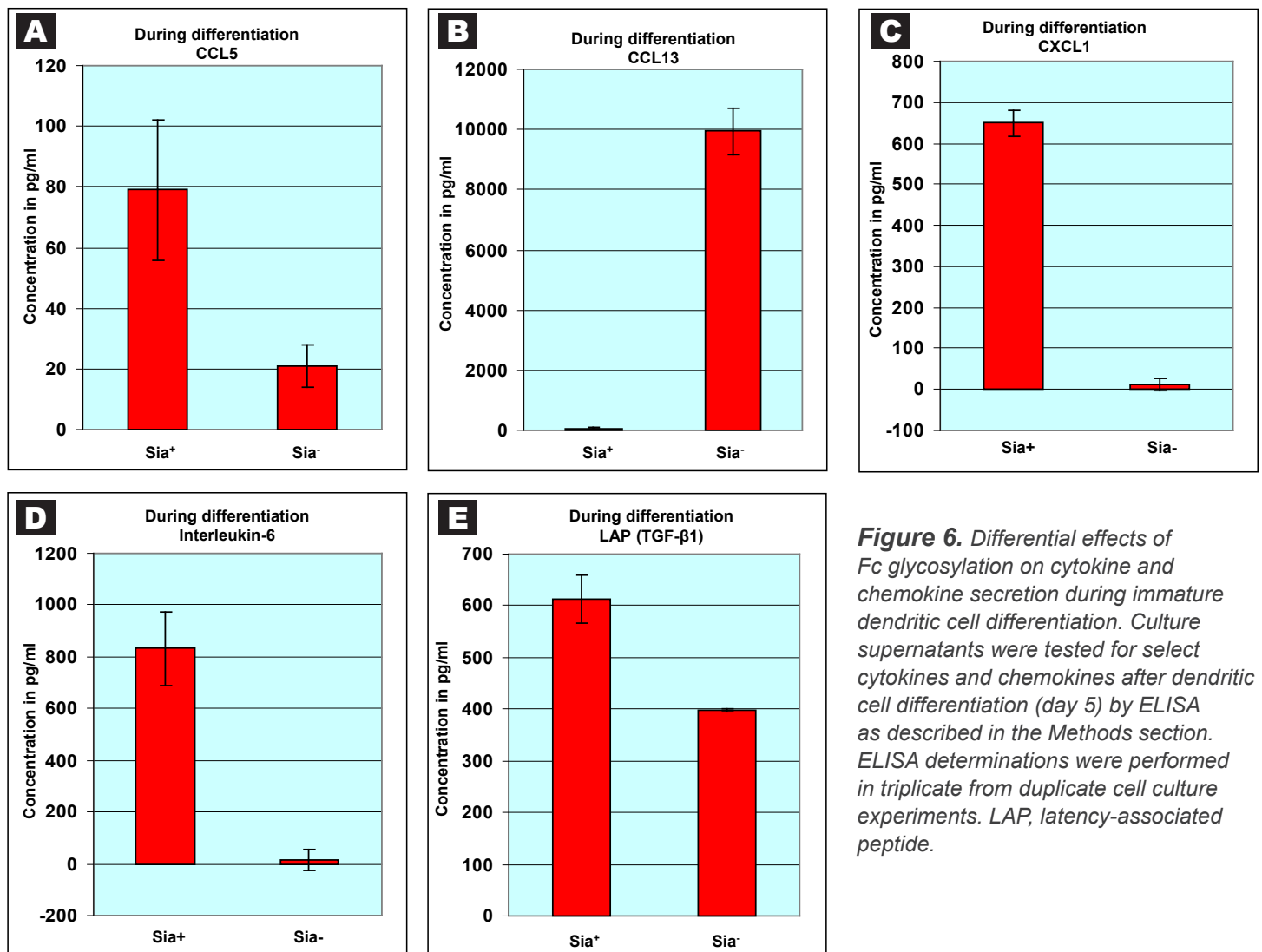

Figure 6. Differential effects of Fc glycosylation on cytokine and chemokine secretion during immature dendritic cell differentiation. Culture supernatants were tested for select cytokines and chemokines after dendritic cell differentiation (day 5) by ELISA as described in the Methods section. ELISA determinations were performed in triplicate from duplicate cell culture experiments. LAP, latency-associated peptide.

to be responsible for sialylation of nascent IgG during immunoglobulin production; however, the possible role of extracellular ST6Gal-I cannot be excluded. For example, the P1 promoter of ST6Gal-I is critical for Fc sialylation, but does not drive ST6Gal-I expression in B-cells. Instead, it promotes synthesis (likely hepatic) of extracellular ST6Gal-I into the systemic circulation.⁴¹ Our previous work does not support a role for Fc sialylation of anti-NY-ESO-1 antibodies in the systemic circulation, as we were unable to establish a relationship with Sia⁺ Fc and functional plasma ST6Gal-I enzymatic activity.⁹ Whether these different isoforms of ST6Gal-I are differentially affected by glucocorticoids and inflammatory cytokines remains to be determined.

Interestingly, we observed little change in iDC or mDC cell surface markers upon treatment with either Sia⁺ or Sia⁻ fractions of NY-ESO-1 IgG when compared to untreated cells. These findings suggest that although these different

IgG glycoforms produce dramatic differential effects on a variety of chemokines, adhesion molecules and cytokines, they do not affect markers of DC lineage. Thus, while these IgG affect the function of DC, they do not appear to affect DC differentiation programs. In addition, they do not appear to change antigen-presenting capacity of HLA-DR or co-stimulatory molecules such as CD80 or CD86, although we did not measure functional ability of these cells to present antigen. These findings appear to be at odds with work published by Bayry and colleagues⁴² who demonstrated a decrease in cell surface expression of HLA-DR, CD40 and CD80 during DC differentiation in the presence of IVIG. It is possible that these differences are due to the authors' use of unfractionated IVIG in which the Sia⁺ fraction would be in a large minority (<1% of Fc glycans and <10% of total IgG glycans³²), whereas our study was performed with purified Sia⁺ IgG. We did, however, notice a modest (approximately 4-fold) decrease in CD80 mRNA during DC maturation.

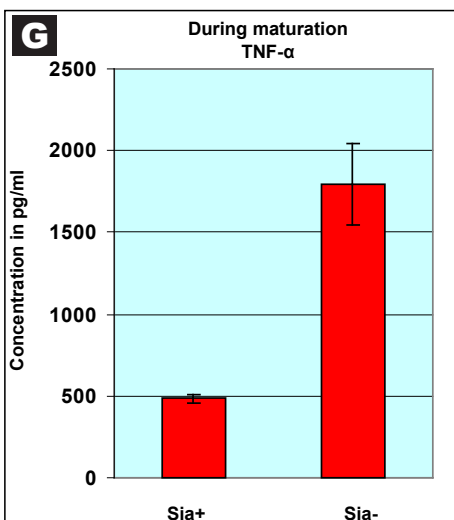
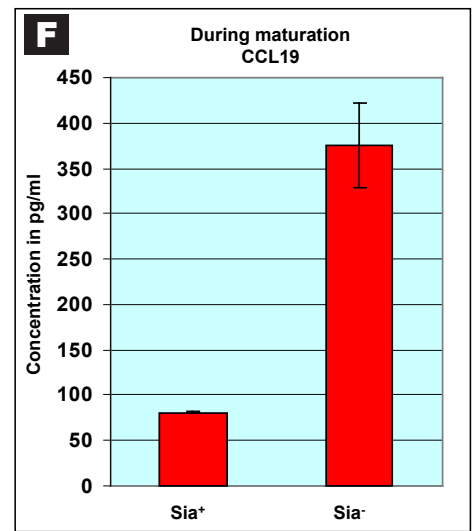
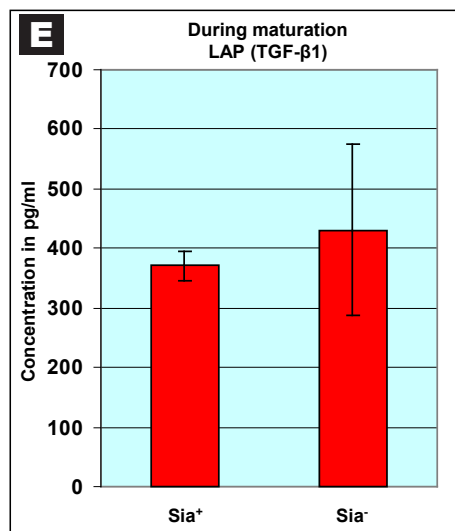
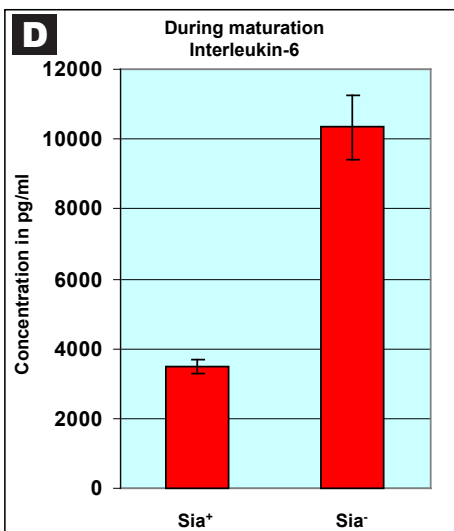
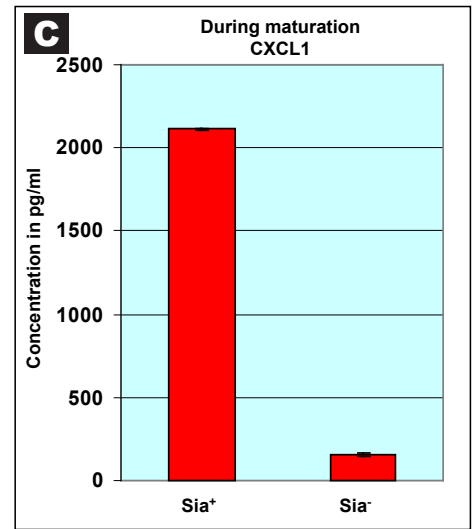
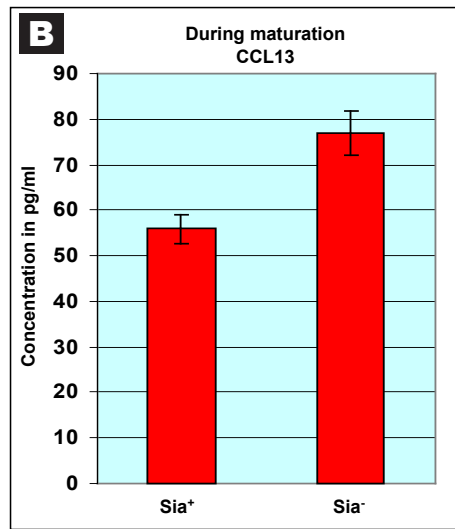
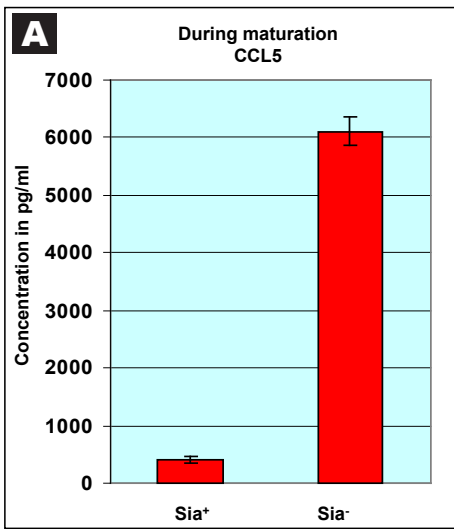

Figure 7. Differential effects of Fc glycosylation on cytokine and chemokine secretion during dendritic cell maturation. Culture supernatants were tested for select cytokines and chemokines after dendritic cell maturation (day 2 posttreatment with lipopolysaccharide) by ELISA as described in the Methods section. ELISA determinations were performed in triplicate from duplicate cell culture experiments. LAP, latency-associated peptide.

Interestingly, Bayry et al. also observed a marked decrease in CD1a cell surface expression in the presence of IVIG, which is consistent with our finding of a 32-fold decrease in CD1a mRNA induced by the Sia⁺ fraction of IgG during DC differentiation. On the other hand, Sia⁺ IgG appeared to increase CD1a mRNA under conditions of DC maturation, so it appears that the same glycoform produces differential effects that are dependent on the activation status of the target DC. CD1a expression appears to define a population of DC that produces functional IL-12,⁴³ and our observation of an increase in the CD1a transcript under conditions of maturation in the presence of Sia⁺ IgG was accompanied by an increase of IL-12B and a decrease in IL-12A mRNA. The functional IL-12 protein (p70) is a heterodimer of the IL-12A and IL-12B subunits and is required for T-cell-independent induction of the inflammatory cytokine interferon- γ .⁴⁴ Thus, although the data suggest an increase in available IL-12B subunit, in the face of reduced levels of IL-12A, we would predict that levels of the mature IL-12 protein would be limited. Our finding of a lack of meaningful change in IL-12p70 protein in culture supernatants of IgG-treated DC further support the concept that despite increase of IL-12B, *functional* IL-12 is blunted by the Sia⁺ IgG fraction. Limiting amounts of IL-12p70 would be consistent with an anti-inflammatory environment in which interferon- γ production is attenuated.

Perhaps the most unexpected and exciting observation during this investigation was the pronounced increased expression of CXCL1 mRNA and protein in DC that had been cultured in the presence of IgG to NY-ESO-1. This was true for DC under both conditions of differentiation and maturation. Our finding that its receptor, CXCR2, is not expressed on either iDC or mDC suggests that CXCL1 protein expression is destined for paracrine function. Because CXCL1 was initially described as melanoma growth stimulating activity- α ,^{45,46} we think it provocative that antibodies to a melanoma antigen (NY-ESO-1) give rise to such a dramatic increase in both mRNA and protein levels. We speculate that CXCL1 drives proliferation of the tumor in an environment that includes a dampening of inflammatory signals, possibly also dampening immunologic recognition. The combined effect of this concert could be tumor growth and progression. These data add additional support to the concept that effector functions of IgG might include both anti-inflammatory activities as well as provide secretion of proteins that directly stimulate growth of melanoma cells.

There remains little dispute that most, if not all, melanomas express antigens that are recognized by the immune

system, and melanoma appears to be the most common tumor in which immunotherapies are successful.⁴⁷ The history of immunotherapy of melanoma includes systemic administration of cytokines such as IL-2 and interferon- α , and the more recent use of immune checkpoint inhibitors such as ipilimumab and PD-1 blockade.⁴⁸ While it might be argued that the success of immunotherapies is due to increased immunogenicity of melanoma, *per se*, we speculate this success might also be related to the dependence of tumor growth and progression on the immune system. Thus, immunologic intervention may not only enhance events downstream of antigen recognition, such as checkpoint blockade, but also by providing growth factors such as CXCL1 that might enhance tumor proliferation. Indeed, specific monocyte-derived DC have been implicated in contributing to tumor development.⁴⁹

Overall, our data describe a unique pattern of mRNA and protein expression in human DC differentiation and maturation induced by the unique glycan structure within populations of IgG antibodies from patients with metastatic melanoma. These unique signatures will be useful in further characterization of the functional differences of IgG antibodies in health and disease. Our findings also lend support to a change in our view of antibodies as limited to providing immunologic memory and inflammatory signals; instead, posttranslational changes in IgG glycan structure can engender immunoglobulins with the ability to control inflammation and perhaps affect both innate and adaptive immune pathways. Much of our current work is focused on investigations into whether they also might be part of a self-regulatory network of neoantibody synthesis. Thus, one can envision a scenario under which ongoing inflammatory humoral immune responses are self-regulated by subtle changes in IgG glycan structure.

Conclusions

The messenger RNA and protein signatures during human dendritic cell differentiation and maturation are differentially influenced by different glycoforms of immunoglobulin G, with specificity for a common antigen expressed in patients with metastatic melanoma. These unique signatures are determined by differences in the glycosylation pattern of these antibodies, specifically, those that terminate in sialic acid. Our findings support the concept that the immune response to melanoma includes a component of antibodies that might promote rather than inhibit tumor growth and progression. Our data support a role for these antibodies in promoting decreased migration, motility and adhesion of inflammatory cells at the tumor site, and inducing soluble

mediators that might stimulate growth of melanoma cells. We believe these findings better our understanding of the tumor/immune system interface and ultimately provide for improvement in immunological interventions for patients with metastatic melanoma.

Lay Conclusions

- The immune system can change the function of antibodies by addition of simple sugars.
- These changes can cause reduced inflammation in tumors.
- Reduced inflammation may allow tumors to progress, grow and spread.
- The immune system plays an important role in cancer progression.

Conflicts of Interest

None.

Acknowledgments

The authors thank the physicians and staff of the immunotherapy program for assistance with obtaining blood samples from melanoma patients. We thank Dr. Nina Garlie for the generous gift of purified monocytes used for these studies, and Dr. Maharaj Singh for assistance with statistical analysis. This work was funded by the Robin Temkin Memorial Gift to Aurora Sinai Medical Center, Milwaukee, WI. Nathaniel Rein was the recipient of the Research Internship Award from the medical staff of Aurora St. Luke's Medical Center, Milwaukee, WI.

References

1. Sahin U, Türeci O, Schmitt H, et al. Human neoplasms elicit multiple specific immune responses in the autologous host. *Proc Natl Acad Sci U S A*. 1995;92:11810-3.
2. Reuschenbach M, von Knebel Doeberitz M, Wentzensen N. A systematic review of humoral immune responses against tumor antigens. *Cancer Immunol Immunother*. 2009;58:1535-44.
3. Kobold S, Lütken T, Cao Y, Bokemeyer C, Atanackovic D. Autoantibodies against tumor-related antigens: incidence and biologic significance. *Hum Immunol*. 2010;71:643-51.
4. Terasaki PI. A personal perspective: 100-year history of the humoral theory of transplantation. *Transplantation*. 2012;93:751-6.
5. Kobashigawa J, Crespo-Leiro MG, Ensminger SM, et al. Report from a consensus conference on antibody-mediated rejection in heart transplantation. *J Heart Lung Transplant*. 2011;30:252-69.
6. Puttarajappa C, Shapiro R, Tan HP. Antibody-mediated rejection in kidney transplantation: a review. *J Transplant*. 2012;2012:193724.
7. Arnold JN, Wormald MR, Sim RB, Rudd PM, Dwek RA. The impact of glycosylation on the biological function and structure of human immunoglobulins. *Annu Rev Immunol*. 2007;25:21-50.
8. Sondermann P, Pincetic A, Maamary J, Lammens K, Ravetch JV. General mechanism for modulating immunoglobulin effector function. *Proc Natl Acad Sci U S A*. 2013;110:9868-72.
9. Oaks M, Taylor S, Shaffer J. Autoantibodies targeting tumor-associated antigens in metastatic cancer: Sialylated IgGs as candidate anti-inflammatory antibodies. *Oncimmunology*. 2013;2:e24841.
10. Radoja S, Rao TD, Hillman D, Frey AB. Mice bearing late-stage tumors have normal functional systemic T cell responses in vitro and in vivo. *J Immunol*. 2000;164:2619-28.
11. Vesely MD, Kershaw MH, Schreiber RD, Smyth MJ. Natural innate and adaptive immunity to cancer. *Annu Rev Immunol*. 2011;29:235-71.
12. Garlie N, Timler A. Dendritic cell generation from cryopreserved monocytes enriched using the Elutra versus the CliniMacs cell separation systems. (abstr.) *J Immunother*. 2005;28:613.
13. Zeng G, Aldridge ME, Wang Y, et al. Dominant B cell epitope from NY-ESO-1 recognized by sera from a wide spectrum of cancer patients: implications as a potential biomarker. *Int J Cancer*. 2005;114:268-73.
14. Ghielmetti M, Bellis M, Spycher MO, Miescher S, Vergères G. Gene expression profiling of the effects of intravenous immunoglobulin in human whole blood. *Mol Immunol*. 2006;43:939-49.
15. Merad M, Sathe P, Helft J, Miller J, Mortha A. The dendritic cell lineage: ontogeny and function of dendritic cells and their subsets in the steady state and the inflamed setting. *Annu Rev Immunol*. 2013;31:563-604.
16. Anthony RM, Kobayashi T, Wermeling F, Ravetch JV. Intravenous gammaglobulin suppresses inflammation through a novel T(H)2 pathway. *Nature*. 2011;475:110-3.
17. Scheller J, Chalaris A, Schmidt-Arras D, Rose-John S. The pro- and anti-inflammatory properties of the cytokine interleukin-6. *Biochim Biophys Acta*. 2011;1813:878-88.
18. Masli S, Turpie B. Anti-inflammatory effects of tumour necrosis factor (TNF)-alpha are mediated via TNF-R2 (p75) in tolerogenic transforming growth factor-beta-treated antigen-presenting cells. *Immunology*. 2009;127:62-72.
19. Baerenwaldt A, Nimmerjahn F. Immune regulation: FcγRIIB-regulating the balance between protective and autoreactive immune responses. *Immunol Cell Biol*. 2008;86:482-4.
20. Baerenwaldt A, Lux A, Danzer H, et al. Fcγ receptor IIB (FcγRIIB) maintains humoral tolerance in the human immune system in vivo. *Proc Natl Acad Sci U S A*. 2011;108:18772-7.
21. Nimmerjahn F, Ravetch JV. FcγRs in health and disease. *Curr Top Microbiol Immunol*. 2011;350:105-25.
22. Redelinghuys P, Brown GD. Inhibitory C-type lectin receptors in myeloid cells. *Immunol Lett*. 2011;136:1-12.
23. Kanazawa N. Dendritic cell immunoreceptors: C-type lectin receptors for pattern-recognition and signaling on antigen-presenting cells. *J Dermatol Sci*. 2007;45:77-86.
24. Anthony RM, Wermeling F, Karlsson MC, Ravetch JV. Identification of a receptor required for the anti-inflammatory activity of IVIG. *Proc Natl Acad Sci U S A*. 2008;105:19571-8.
25. Anthony RM, Wermeling F, Ravetch JV. Novel roles for the IgG Fc glycan. *Ann N Y Acad Sci*. 2012;1253:170-80.
26. Baekkevold ES, Roussigné M, Yamanaka T, et al. Molecular characterization of NF-HEV, a nuclear factor preferentially expressed in human high endothelial venules. *Am J Pathol*. 2003;163:69-79.
27. Moussion C, Ortega N, Girard JP. The IL-1-like cytokine IL-33 is constitutively expressed in the nucleus of endothelial cells and epithelial cells in vivo: a novel 'alarmin'? *PLoS One*. 2008;3:e3331.

28. Moussion C, Girard JP. [High endothelial venules (HEVs) and dendritic cells: a key functional unit for lymphocyte migration]. *Med Sci (Paris)*. 2012;28:347-9.
29. Moussion C, Girard JP. Dendritic cells control lymphocyte entry to lymph nodes through high endothelial venules. *Nature*. 2011;479:542-6.
30. Maresco DL, Chang E, Theil KS, Francke U, Anderson CL. The three genes of the human FCGR1 gene family encoding Fc gamma RI flank the centromere of chromosome 1 at 1p12 and 1q21. *Cytogenet Cell Genet*. 1996;73:157-63.
31. Pang J, Taylor GR, Munroe DG, et al. Characterization of the gene for the human high affinity IgE receptor (Fc epsilon RI) alpha-chain. *J Immunol*. 1993;151:6166-74.
32. Kaneko Y, Nimmerjahn F, Ravetch JV. Anti-inflammatory activity of immunoglobulin G resulting from Fc sialylation. *Science*. 2006;313:670-3.
33. Kanazawa N, Okazaki T, Nishimura H, Tashiro K, Inaba K, Miyachi Y. DCIR acts as an inhibitory receptor depending on its immunoreceptor tyrosine-based inhibitory motif. *J Invest Dermatol*. 2002;118:261-6.
34. Massoud AH, Yona M, Xue D, et al. Dendritic cell immunoreceptor: a novel receptor for intravenous immunoglobulin mediates induction of regulatory T cells. *J Allergy Clin Immunol*. 2014;133:853-63.
35. Bartholomew BA, Jourdain GW, Roseman S. The sialic acids. XV. Transfer of sialic acid to glycoproteins by a sialyltransferase from colostrum. *J Biol Chem*. 1973;248:5751-62.
36. Hanasaki K, Varki A, Stamenkovic I, Bevilacqua MP. Cytokine-induced beta-galactoside alpha-2,6-sialyltransferase in human endothelial cells mediates alpha 2,6-sialylation of adhesion molecules and CD22 ligands. *J Biol Chem*. 1994;269:10637-43.
37. Dalziel M, Lemaire S, Ewing J, Kobayashi L, Lau JT. Hepatic acute phase induction of murine beta-galactoside alpha 2,6 sialyltransferase (ST6Gal I) is IL-6 dependent and mediated by elevation of exon H-containing class of transcripts. *Glycobiology*. 1999;9:1003-8.
38. Wang XC, O'Hanlon TP, Lau JT. Regulation of beta-galactoside alpha 2,6-sialyltransferase gene expression by dexamethasone. *J Biol Chem*. 1989;264:1854-9.
39. Wuensch SA, Huang RY, Ewing J, Liang X, Lau JT. Murine B cell differentiation is accompanied by programmed expression of multiple novel beta-galactoside alpha2, 6-sialyltransferase mRNA forms. *Glycobiology*. 2000;10:67-75.
40. Lo NW, Dennis JW, Lau JT. Overexpression of the alpha2, 6-sialyltransferase, ST6Gal I, in a low metastatic variant of a murine lymphoblastoid cell line is associated with appearance of a unique ST6Gal I mRNA. *Biochem Biophys Res Commun*. 1999;264: 619-21.
41. Jones MB, Nasirikenari M, Lugade AA, Thanavala Y, Lau JT. Anti-inflammatory IgG production requires functional P1 promoter in beta-galactoside alpha2,6-sialyltransferase 1 (ST6Gal-1) gene. *J Biol Chem*. 2012;287:15365-70.
42. Bayry J, Lacroix-Desmazes S, Carbonneil C, et al. Inhibition of maturation and function of dendritic cells by intravenous immunoglobulin. *Blood*. 2003;101:758-65.
43. Cernadas M, Lu J, Watts G, Brenner MB. CD1a expression defines an interleukin-12 producing population of human dendritic cells. *Clin Exp Immunol*. 2009;155:523-33.
44. Wolf SF, Temple PA, Kobayashi M, et al. Cloning of cDNA for natural killer cell stimulatory factor, a heterodimeric cytokine with multiple biologic effects on T and natural killer cells. *J Immunol*. 1991;146:3074-81.
45. Haskill S, Peace A, Morris J, et al. Identification of three related human GRO genes encoding cytokine functions. *Proc Natl Acad Sci U S A*. 1990;87:7732-6.
46. Lázár-Molnár E, Hegyesi H, Tóth S, Falus A. Autocrine and paracrine regulation by cytokines and growth factors in melanoma. *Cytokine*. 2000;12:547-54.
47. Garbe C, Eigentler TK, Keilholz U, Hauschild A, Kirkwood JM. Systematic review of medical treatment in melanoma: current status and future prospects. *Oncologist*. 2011;16:5-24.
48. Drake CG, Lipson EJ, Brahmer JR. Breathing new life into immunotherapy: review of melanoma, lung and kidney cancer. *Nat Rev Clin Oncol*. 2014;11:24-37.
49. Augier S, Ciucci T, Luci C, Carle GF, Blin-Wakkach C, Wakkach A. Inflammatory blood monocytes contribute to tumor development and represent a privileged target to improve host immunosurveillance. *J Immunol*. 2010;185:7165-73.

© 2014 Aurora Health Care, Inc.